

Systems Biology Results Markup Language (SBRML) Level 1: Structure and Facilities for Results Representation

Joseph O. Dada, Irena Spasic, Norman W. Paton, Pedro Mendes

`joseph.dada@manchester.ac.uk`, `i.spasic@manchester.ac.uk`, `norm@cs.man.ac.uk`, `pedro.mendes@manchester.ac.uk`

School of Computer Science &
Manchester Centre for Integrative Systems Biology,
University of Manchester,
Oxford Road, Manchester M13 9PL
United Kingdom

SBRML Level 1 Version 1
Release 1

Contents

1 Introduction.....	4
1.1 Models and their states.....	4
1.2 Model analyses.....	5
1.3 Organizing simulation results.....	5
1.4 Document conventions.....	6
1.4.1 Color conventions	6
1.4.2 Typographical convection for names.....	6
1.4.3 UML Notation.....	7
2 Overview of SBRML.....	9
3 Preliminary definitions and principles.....	10
3.1 Primitive data types	10
3.1.1 Type SBRIId.....	11
3.1.2 Type DataType.....	11
3.2 Type SBRBase.....	11
3.2.1 The metaid attribute.....	12
3.2.2 The notes association	12
3.2.3 The annotation association	12
4 SBRML components.....	13
4.1 The SBRML container.....	13
4.2 Ontology Term.....	14
4.2.1 The id attribute.....	14
4.2.2 The term, sourceTermId, and sourceURI attributes.....	14
4.2.3 Example.....	14
4.3 Model.....	15
4.3.1 The name and sourceURI attributes.....	15
4.3.2 The sbml association.....	15
4.3.3 Example.....	15
4.4 Operation.....	15
4.4.1 The id and names attributes	16
4.4.2 The ontologyTerm association.....	16
4.4.3 Example.....	16
4.5 Method.....	17
4.5.1 The name attribute.....	17
4.5.2 The ontologyTerm association.....	17
4.5.3 Example.....	17
4.6 Software.....	17
4.6.1 The name, version, URL attributes.....	18
4.6.2 Example.....	18
4.7 Result.....	18
4.7.1 Example.....	19
4.8 Result component.....	19
4.8.1 The id attribute	19
4.9 The dimension description	20
4.10 The composite description	20
4.11 The tuple description	20
4.12 The atomic description	20
4.13 The dimension	20
4.14 The composite value	20

4.15 The tuple	21
4.16 The atomic value	21
4.17 Example with tuple and atomic value.....	21
4.18 Example with composite value(s) and atomic value	21
4.19 Example with composite value, tuple and atomic value.....	22
5 Example of simulation results expressed in XML using SBRML.....	22
5.1 Example of steady state simulation result.....	22
5.2 Example of time course simulation result.....	24
5.3 Example of parameter scan result.....	27
5.4 Online example of simulation results.....	28
Acknowledgements.....	28
Appendix B: XML Schema for SBRML.....	30
References.....	33

1 Introduction

The introduction of SBML as an exchange format for models of biochemical systems has been a major factor in advancing computational systems biology. The community of scientists and software developers involved with SBML (hereafter called the “SBML community”) has also made several other technical advances as a consequence, for example by creating software libraries that make it easier to develop programs compatible with SBML, and by creating collections of models that act as gold standards for testing and therefore also for validating and comparing software. There have also been several other standardization activities, for example in defining what information should be communicated when models are constructed. However, one aspect that has until now not been addressed in terms of standardization is the specification of the results of computational analyses of systems biology models (simulation results, etc.). Standardization of results will bring obvious benefits in terms of storage and retrieval, but will also benefit any program that needs to read data in the context of a biochemical model. One example is in parameter estimation, where software changes a model to match it to some given experimental data. This document is intended to propose a solution addressing this issue and will be proposed for discussion at the 2008 SBML Forum. It is hoped that it will generate discussion among the SBML community and after appropriate modifications result in a final specification for a Systems Biology Results Markup Language (SBRML).

1.1 Models and their states

The central concept in systems biology is a *model of a biochemical system* and it is important for the purposes of this document to provide an operational definition of what such a model consists of.

A computational/mathematical view of models is that they are a set of *functions* and associated *parameter values* that map a transformation of a system from an initial *state* to a final *state*. A simulation can then be seen as a transformation between two states carried out by a set of mathematical equations (embodied in computational methods). This view is generic and includes several types of simulation (eg time courses, steady states, etc) and different mathematical frameworks (sets of ODEs, Gillespie's SSA, Petri nets, etc.). Such models can be represented using SBML files.

An important note regards the very special model entity known as “time”. This is usually seen as a special independent variable of models and a large set of analyses are concerned with how the system changes its state along monotonically increasing values of time (time course simulations). However, for the purposes of this document and of the proposed markup language (SBRML), it is useful to regard “time” as just any other parameter of the model, like kinetic constants.

As will be argued in more detail below, the product of computational systems biology analyses are always collections of states of the system, each one associated with the values of the parameters that generate them. So it becomes important to first create a data model for the state of a system.

A single state of a system/model is thus characterized by 1) a set of parameter values, and 2) a set of values of the state variables. In more detail we have:

1. A set of parameter values of the model that specify the state:
 - 1.1. kinetic constants of the rate laws of all reactions
 - 1.2. initial concentrations of all species

- 1.3. values of any arbitrary constants
 - 1.4. initial values of any arbitrary dependent variables
 - 1.5. initial values of compartment volumes
 - 1.6. initial time value (usually zero, but can be different in non-autonomous models)
2. A set of values of the state variables (that uniquely defines the state):
 - 2.1. species concentrations or particle numbers
 - 2.2. compartment volumes
 - 2.3. arbitrary dependent variables

A state of a biochemical model also includes a number of other quantities that can be derived from the set in 2. above. For example the reaction fluxes are a function of the species concentrations (through the reaction kinetic rate laws). A list of such quantities includes:

3. Derived state variables:
 - 3.1. reaction fluxes (either in concentration or particle numbers)
 - 3.2. Jacobian matrix (contains the partial derivatives of the ODEs)
 - 3.3. Eigenvalues of the Jacobian matrix
 - 3.4. Arbitrary sensitivity coefficients
 - 3.5. Lyapunov exponents
 - 3.6. Elasticity coefficients
 - 3.7. Concentration-control coefficients
 - 3.8. Flux-control coefficients
 - 3.9. Response coefficients (defined as the total derivative of a variable towards some parameter)
 - 3.10. Any other function of the primary state variables variables (or from any other derived state variable)

Any quantity that, in order to be calculated, requires the determination of any primary state variable is thus a derived state variable. The distinction between primary and derived state variables is important because the primary state variables are the only ones required to determine unequivocally the state of the system – they are the most basic properties of that system. Given the complete set of primary state variables of a model and its equations, it is possible to determine a finite number of sets of parameter values that could lead to such states (even if this is technically difficult).

1.2 Model analyses

The simplest operation that can be applied to this type of model is the calculation of a “final” state of the system based on a given initial state. The majority of operations are actually composed of several of these calculations where something is changed in the model, thus the results file should be able to represent not just one “final” state, but rather several of them and they should be associated with the conditions particular to each one of them.

One can calculate the state of the system for any value of time, and thus a time series is nothing more than a set of states of the system, each one associated with a different value of time. Steady states are special instances of the system where the state corresponds to the case of time=infinity (because they are asymptotic).

1.3 Organizing simulation results

Results can be expressed for a single state of the model or for multiple states of the model. For the purpose of this markup language it is useful to first define how to specify results for a single state. Then to organize collections of states there are two options: *i*) list all states as tuples containing parameter values and values of state variables; or *ii*) have tuples that contain only values of state variables and then index them by parameter values. The first case corresponds to a simple list of results and is appropriate when the parameter values are not ordered and/or have irregular intervals. The second is most appropriate when the parameter values change in regular ways and take many different values. An example of the first case would be a list of results from a random sampling of values of five parameters of the model; an example of the second would be the time series resulting from a specific initial condition, which is then iterated for several different values of four parameters in a regular sweep (*i.e.* exploring the dynamics at all values of those four parameters). The former case would be a simple list, the latter would be a four dimensional data cube.

1.4 Document conventions

In this section, we describe the conventions we use in this specification document in an effort to communicate information more effectively and consistently.

1.4.1 Color conventions

Throughout this document, we use coloring to carry additional information for the benefit of those viewing the document on media that can display color:

We use blue color in text to indicate a hyperlink from one point in this document to another. Clicking your computer's pointing device on blue-colored text will cause a jump to the section, figure, table or page to which the link refers. (Of course, this capability is only available when using electronic formats that support hyper linking, such as PDF and HTML.)

1.4.2 Typographical convection for names

The following typographical notations are used in this document to distinguish objects and data types from other kinds of entities:

AbstractClass: Abstract classes are classes that are never instantiated directly, but rather serve as parents of other classes. Their names begin with a capital letter and they are printed in a slanted, bold, sans-serif typeface (e.g. ***AbstractClass***). In electronic document formats, the class names are also hyper linked to their definitions in the specification. For example, in the PDF and HTML versions of this document, clicking on the word [SBRbase](#) will send the reader to the section containing the definition of this class.

Class: Names of ordinary (concrete) classes begin with a capital letter and are printed in an upright, bold, sans-serif typeface (e.g. **MyClass**). In electronic document formats, the class names are also hyper linked to their definitions in the specification. For example, in the PDF and HTML versions of this document, clicking on the word [Model](#) will send the reader to the section containing the definition of this class.

Something, otherThing: Attributes of classes, data type names, literal XML, and generally all

tokens other than SBRML UML class names, are printed in an upright typewriter typeface (e.g. myAttributeName). Primitive types defined by SBRML begin with a capital letter, but unfortunately, XML Schema 1.0 does not follow any convention and primitive XML types may either start with a capital letter (e.g. ID) or not (e.g., double).

1.4.3 UML Notation

The Unified Modeling Language (UML) is the Object Management Group (OMG) (<http://www.omg.org/>) specification defining a graphical language for visualising, specifying, constructing, and documenting the artifacts of object-based software. SBRML uses a subset of the UML standard, the class diagram, which represent a static view of the data structure. There are three main advantages of using UML as basis for defining SBRML data objects. First, compared to using other notations or a programming language, the UML visual representations are generally easier to grasp by readers who are not computer scientists. Second, the notation is implementation-neutral: the objects can be encoded in any concrete implementation language—not just XML, but C, Java and other languages as well. Third, UML is a *de facto* industry standard that is documented in many resources. Readers are therefore more likely to be familiar with it than other notations.

Object class definitions

Object classes in UML diagrams are drawn as simple tripartite boxes, as shown in Figure 1.1. The top box contains the name of the class. The middle box contains a list of attributes. Attributes in SBRML data model are defined as optional (“0..1”) or mandatory (“1”) by the cardinality specified next to class attribute name. The bottom box of a UML class contains a listing of the operations that are performed by the class. This box is not used in SBRML because we are only interested in data model; hence the box is empty.

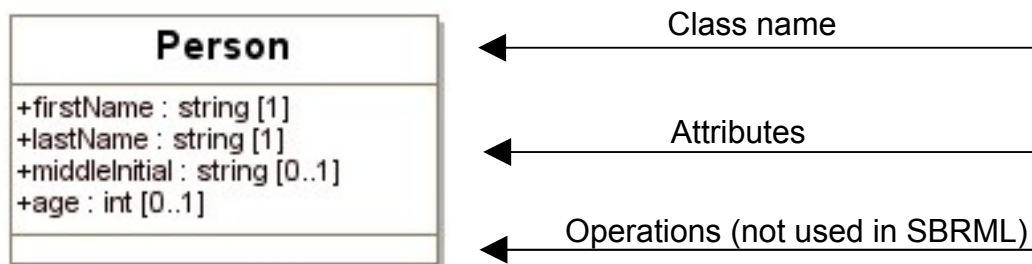

Figure 1.1: UML Class with boxes outlined

As mentioned above, the names of ordinary (concrete) classes begin with a capital letter and are printed in an upright, bold, san-serif typeface. The names of attributes begin with a lower-case letter and generally use a mixed case (sometimes called "camel case") style when the name consists of multiple words. Attributes and their data types appear in the part below the class name, with one attribute defined per line. The colon character on each line separates the name of the attribute (on the left) from the type of data that it stores (on the right). The subset of data types permitted for SBRML attributes is given in Section 3.1. In the diagram of Figure 1.1, the firstName, lastName, middleInitial and age represent attributes of the object class **Person**. The data type of firstName, lastName, and middleInitial is string, and the data type of age is int. In the scheme used by SBRML for translating UML to XML, object attributes map directly to XML attributes. Thus, in XML, **Person** would yield an element of the form `<element firstName="John" lastName="Pama" age="23">`.

Notice that the element name is not **<Person ...>**. Somewhat paradoxically, the name of the element is not the name of the UML class defining its structure. The reason for this may be subtle at first, but quickly becomes obvious: object classes define the form of an object's content, but a class definition by itself does not define the label or symbol used to mark up an instance of that content. It is this label that becomes the name of the XML element. In XML, this symbol is most naturally equated with an element name. This point will hopefully become clearer with additional examples below.

UML relationships

There are two types of relationships between classes in SBRML: associations and generalisations. Association relationships between classes are shown as an arc joining the two classes (Figure 1.2), with the name of the association next to the arc. The multiplicity/cardinality of associations specifies how many instances of one class may relate to a single instance of another class. This is shown by numbers and stars at the end of an association path. The multiplicity may be one-to-one, one-to-many, optional, and many-to-many. Associations are either bi-directional, meaning each association end is accessible from the other (hence both classes can traverse the relation), or unidirectional, meaning only one association end is accessible and the relation can only be traversed in one direction. Only unidirectional associations are used in SBRML.

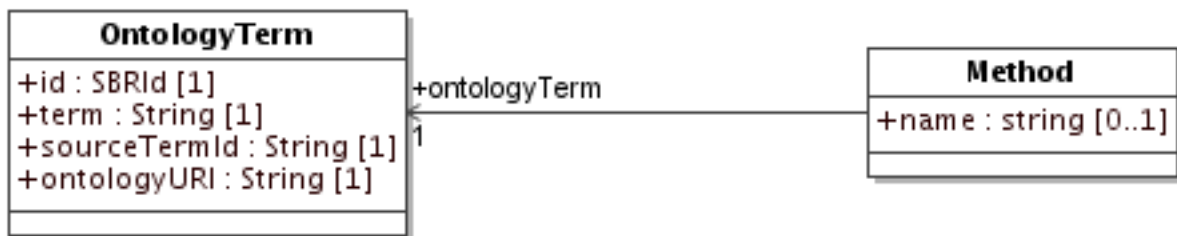

Figure 1.2: Example illustrating unidirectional association between Method and OntologyTerm classes. In this example, the unique ID of the reference element is an attribute of the associating element, with the name of the association.

Composition and aggregation associations

Composition and aggregation are special forms of relationship in which the classes are tightly bound by the whole/part relationship. The composition association is a stronger form of whole/part relationship than the aggregation relationship. We use UML composition and aggregation association to indicate a class instance can have other class instances as parts. Such containment hierarchies map directly to element-subelement relationships in XML. Figure 1.3 gives an example.



Figure 1.3: Example illustrating composition association: the definition of one class of objects employing another class of objects in a part-whole relationship. In this particular example, an instance of a Whole class object must contain exactly one instance of a Part class object, and the symbol referring to the Part class object is part. In XML, this symbol becomes the name of a subelement and the content of the subelement follows the definition of Part.

The line with the black diamond indicates composition association, with the diamond located on the "container" side and the other end located at the object class being contained. A hollow diamond

indicates aggregation association. The label on the line is the symbol used to refer to instances of the contained object, which in XML, maps directly to the name of an XML element. The class pointed to by the aggregation relationship (Part in Figure 1.3) defines the contents of that element. Thus, if we are told that some element named barney is of class Whole, the following is an example XML fragment consistent with the class definition of Figure 1.2:

```
<barney A="210" B="some string">
  <part C="222.2">
</barney>
```

Sometimes numbers are placed above the line near the "contained" side of an aggregation to indicate how many instances can be contained. The common cases in SBRML are the following: (0..*) to signify a list containing zero or more; (1..*) to signify a list containing at least one; (1) to signify exactly one; and (0..1) to signify exactly zero or one. This notation appears throughout this specification document.

Inheritance or generalisation

Classes can inherit properties from other classes. Since SBRML only uses data attributes and not operations, inheritance in SBRML simply involves data attributes from a parent class being inherited by child classes. Inheritance is indicated by a line between two classes, with an open triangle next to the parent class; Figure 1.3 illustrates this. In this example, the instances of object class **Child** would have not only attributes C and D, but also attributes A and B. All of these attributes would be required (not optional) on instances of class **Child** because they are mandatory on both **Parent** and **Child**.

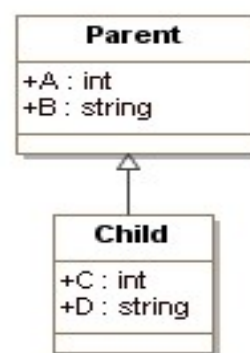

Figure 1.3: Inheritance

Additional notations for XML purposes

Not everything is easily expressed in plain UML. For example, it is often necessary to indicate some constraints placed on the values of an attribute. In computer programming uses of UML, such constraints are often expressed using Object Constraint Language (OCL), but since we are most interested in the XML rendition of SBRML, in this specification we use XML Schema 1.0 (when possible) as the language for expressing value constraints.

2 Overview of SBRML

The initial state of a biochemical reaction network is defined in an SBML model. To simulate and analyse the reaction network, a software package takes the SBML model as input and transforms that initial state through a specific operation. The outcome of an operation is a new state of the system. The new state, which may be single or multiple states, are captured and described in SBRML. The result of an operation consists of one or more result components. Software tools implement an operation using a specific method. The ontology term defines the source of term/vocabulary used in SBRML. For example, the name of the method used in an operation and operation name (e.g. steady state, time course, parameter scan, parameter estimation, etc.) are captured in an ontology term definition.

SBRML is intended to allow any type of systems biology results to be represented. It is currently structured as follows: On the top level, SBRML consists of ontology terms, model, and operations. The second level describes each operation application, which consists of software, method and

result. The next level is the content of the result, which consists of one or more result components. Each result component consists of the description of the data being represented and the data itself. The basic structure of the SBRML object model (<http://www.uml.org>) and XML Schema (Biron & Malhotra, 2000) is presented in Figure 2.1

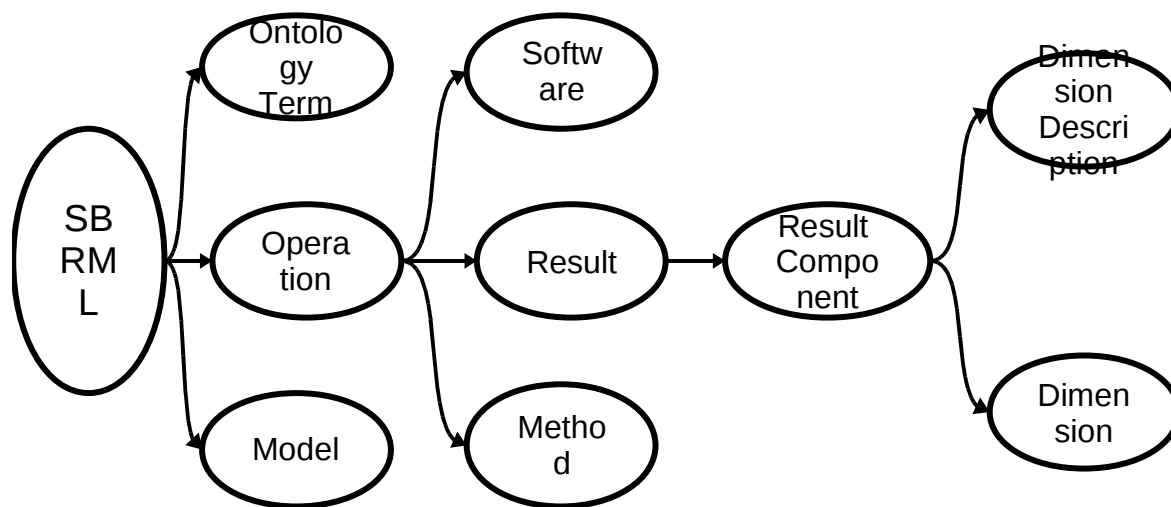

Ontology Term	Provides a flexible means for referencing external ontology sources for vocabularies/terms used in SBRML.
Model	Defines the model used to generate the result.
Operation	Captures the operation that is performed on the model.
Software	Defines the software used to perform the operation on the model.
Method	Defines the method used in the operation.
Result	Captures all the results of an operation on the model.
Result Component	Captures the individual component of result.
Dimension Description	A header of a result component. It describes the data in the component.
Dimension	Captures the actual data of the result component.

Figure 2.1: Basic structure of SBRML

3 Preliminary definitions and principles

This section covers certain concepts and constructs that are used repeatedly in the rest of SBRML Level 1.

3.1 Primitive data types

Most primitive types in SBRML are taken from the data types defined in XML Schema 1.0 (Biron and Malhotra, 2000; Fallside, 2000; Thompson et al., 2000). In particular, this is the case for string, positiveInteger, ID and double. A few other primitive types are defined by SBRML itself. What follow is a summary of the definitions of the SBRML-specific types. Readers should consult the

XML Schema 1.0 specification for the normative definitions of the XML types used by SBRML.

3.1.1 Type SBRId

The type SBRId is the type of the id attribute found on the majority of SBRML components. SBRId is a data type derived from the basic XML type string, but with restrictions about the characters permitted and the sequences in which those characters may appear. The definition is shown in Figure 3.1.

```
letter ::= 'a'..'z', 'A'..'Z'  
digit  ::= '0'..'9'  
idChar ::= letter | digit | '_' | '-'  
SBRId  ::= ( letter | '-' ) idChar*
```

Figure 3.1: The definition of the type SBRId expressed in the variant of BNF used by the XML 1.0 specification (Bray et al., 2004). The characters (and) are used for grouping, the character * indicates "zero or more times", and the character | indicates "or". The production **letter** consists of the basic upper and lower case alphabetic characters of the Latin alphabet along with a large number of related characters defined by Unicode 2.0; similarly, the production **digit** consists of the numerals 0..9 along with related Unicode 2.0 characters.

The equality of SBRId values is determined by an exact character sequence match; i.e., comparisons of these identifiers must be performed in a case-sensitive manner. This applies to all uses of SBRId. The SBRId is purposefully not derived from the XML ID type (introduction section). Using XML's ID would force all SBRML identifiers to exist in a single global namespace, which would affect future SBRML extensions for supporting result composition. Finally, unlike ID, SBRId does not include Unicode character codes; the identifiers are plain text.

3.1.2 Type DataType

The type DataType (Figure 3.2) is an enumeration type for specifying the type of valueType attribute on AtomicDescription and indexType attribute on CompositeDescription.

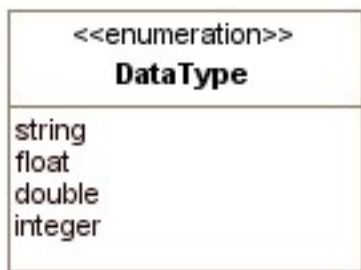

Figure 3.2: The definition of `DataType`

3.2 Type SBRBase

Nearly every object composing an SBRML Level 1 model definition has a specific data type that is derived directly or indirectly from a single abstract type called SBRBase. In addition to serving as the parent class for most other classes of objects in SBRML, this base type is designed to allow a user or a software package to attach arbitrary information to each major element in SBRML model. The definition of SBRBase (Figure 3.3) is the same as Sbase in SBML. The only difference is that there is no SBOTerm attribute in SBRML. All ontology terms in SBRML are defined in the `OntologyTerm` class. SBRBase contains one attribute and has two subelements, all of which are

optional: metaid, notes and annotation. These are discussed separately in the following subsections.

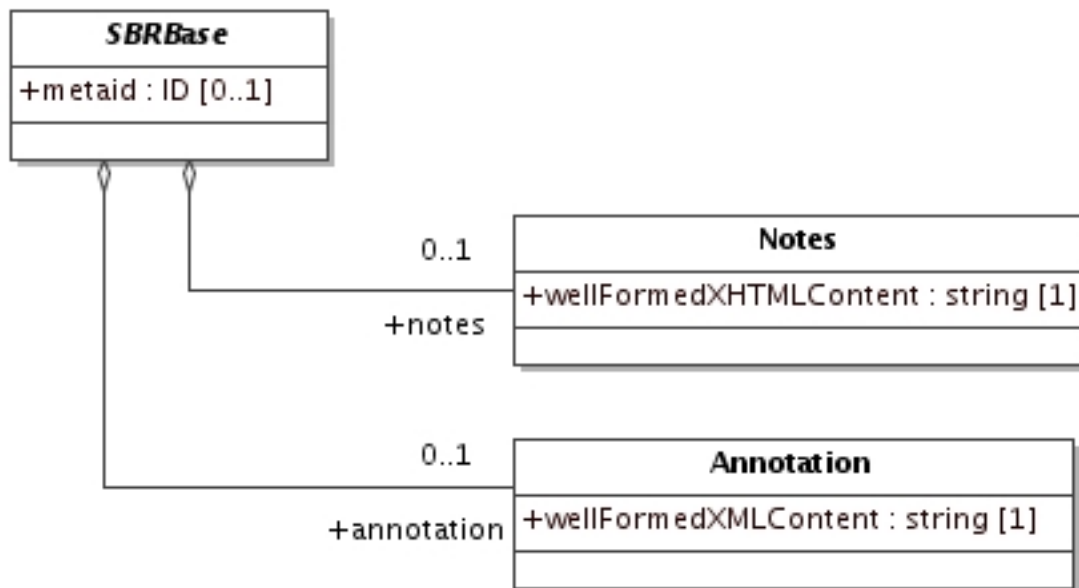

Figure 3.3: The definition of SBRBase.

3.2.1 The metaid attribute

The metaid attribute is present for supporting metadata annotations using RDF (Resource Description Format; Lassila and Swick, 1999). It has a data type of XML ID (the XML identifier type; see Section 3.1.6), which means each metaid value must be globally unique within an SBRML file. The metaid value serves to identify a model component for purposes such as referencing that component from metadata placed within annotation elements (see Section 3.2.3). Such metadata can use RDF description elements, in which an RDF attribute called "rdf:about" points to the metaid identifier of an object defined in the SBRML model.

3.2.2 The notes association

The association notes in SBRbase represents a container element for XHTML 1.0 (Pemberton et al., 2002) content. It is intended to serve as a place for storing optional information intended to be seen by humans. An example use of the notes association would be to contain formatted user comments about the SBRML element in which the notes container element is enclosed. Every object derived directly or indirectly from type SBRbase can have a separate value for notes, allowing users considerable freedom when adding comments to simulation results.

3.2.3 The annotation association

Whereas the notes association described above represents a container element for content to be shown directly to humans, the annotation association represents a container element for optional software-generated content not meant to be shown to humans. Every object derived from SBRbase can have its own value for annotation. The element's content type is XML type any, allowing essentially arbitrary well-formed XML data content. The same restrictions placed on the organization of the annotation content in SBML also apply to SBRML.

4 SBRML components

In this section, we define each of the major components of SBRML. We use the UML notation described in the introduction for defining classes of objects. We also illustrate the use of SBRML components by giving partial model definitions in XML. Section 5 provides many full examples of SBRML in XML

4.1 The SBRML container

All well-formed XML documents must begin with an XML declaration, which specifies both the version of XML assumed and the document character encoding. The declaration begins with the characters `<?xml` followed by the XML version and encoding attributes. SBRML Level 1 uses XML version 1.0 and requires a document encoding of UTF-8. Following this XML declaration, the outermost portion of a simulation result/experimental data expressed in SBRML Level 1 Version 1 consists of an object of class `Sbrml`, defined in Figure 4.1. This class contains two required attributes, for the SBRML level and version, and three required subelements; `model`, `operations`, and `ontologyTerms`. The `model` subelement is defined in the `Model` class. The `operation` and `ontologyTerm` subelements are defined in the classes `Operation` and `OntologyTerm` respectively. The `operations` and `ontologyTerms` are container elements. The `operations` element contains at least one instance of `Operation` while `ontologyTerms` element contains instances of `OntologyTerm`.

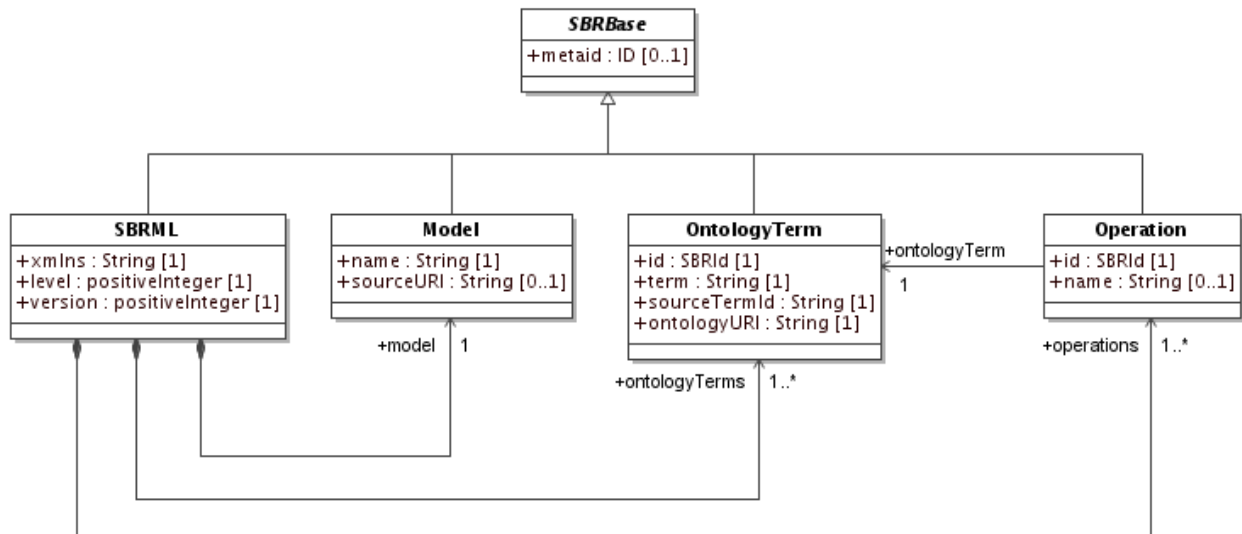

Figure 4.1: The definition of class `Sbrml`. The classes `Model`, `OntologyTerm`, `Operation` are defined in Subsection 4.2, 4.3, 4.4, respectively.

The following is an abbreviated example of the associated XML elements for an SBRML Level 1 Version 1 document:

```

<?xml version="1.0" encoding="UTF-8"?>
<sbrml xmlns="http://www.sbrml.org/sbrml/level1/version1">
  <ontologyTerms>.....</ontologyTerms>
  <model ..... />
  <operations>.....</operations>
</sbrml>
  
```

The attribute `xmlns` declares the default XML namespace used within the `sbrml` element. The URI for SBRML Level 1 Version 1 is `http://www.sbrml.org/sbrml/level1/version1`. All elements must be placed in this namespace either by assigning the default namespace as shown above, or using a tag prefix on every element.

An SBRML XML document must not contain elements or attributes in the SBRML namespace that are not defined in this SBRML Level 1 Version 1 Release 1 specification. Documents containing unknown elements or attributes placed in the SBRML namespace do not conform to this SBRML specification.

4.2 Ontology Term

The use of vocabularies/terms from standard ontology source to describe various types of data associated with the model is very important in order for software tools to correctly interpret the data. There is no single ontology source that can provide all the terms needed for the description of the very diverse systems biology data. SBRML provides a good model and flexible mechanism for referencing terms from any ontology sources. All terms already defined in SBML model e.g. species, reaction, etc. should be used for data description without specifying any ontology source for them. The definition of `OntologyTerm` object class for representing vocabularies and ontologies is presented in Figure 4.2.

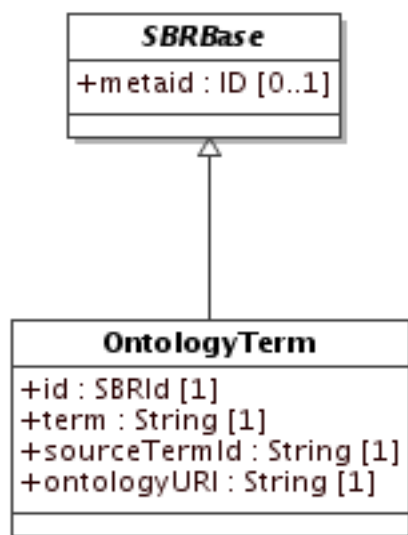

Figure 4.2: The definition of class `OntologyTerm`. A sequence of one or more instances of `OntologyTerm` used elsewhere in the SBRML document are located in the `ontologyTerms` container element of `Sbrml` as earlier described.

4.2.1 The id attribute

The mandatory `id` attribute is of type `SBRIId`, and provides a unique identifier for the ontology term.

4.2.2 The term, sourceTermId, and sourceURI attributes

The `term` attribute stores the term itself while the `sourceTermId` is a string that is used within the ontology source to identify uniquely the concept being referenced by the SBRML object. The `ontologyURI` specifies the unique identifier of the ontology source.

4.2.3 Example

```

<sbrml>
.....
  
```

```

<ontologyTerms>
  <ontologyTerm id="term1" term="concentration" sourceTermId="SBO:0000196" ontologyURI="http://www.ebi.ac.uk/sbo/">
    .....
  </ontologyTerm>
</ontologyTerms>
.....
</sbrml>

```

4.3 Model

Model describes the SBRML model from which the simulation results were generated as a result of the operation that is performed on the model. The definition of Model is shown in Figure 4.3. Only one instance of a Model object is allowed per instance of an SBRML Level 1 Version 1 Release document, and it must be located inside the <sbrml> ... </sbrml> element as described in Section 4.1.

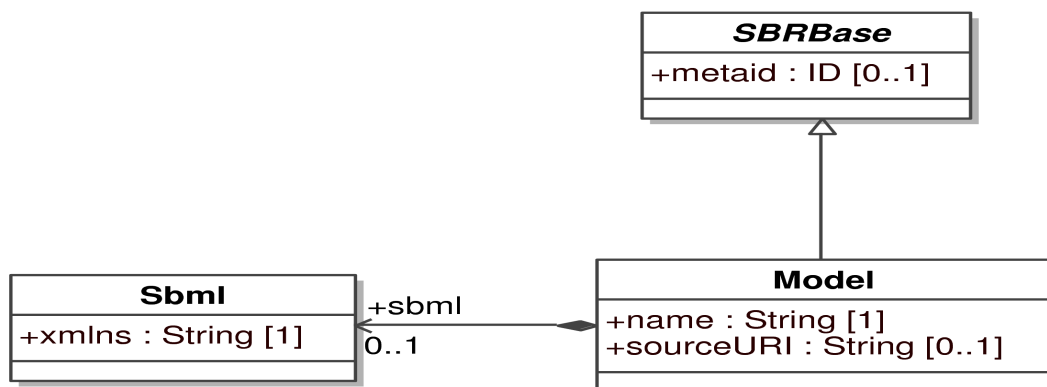

Figure 4.3: The definition of class Model. Only one instance of Model can be located in an SBRML document.

4.3.1 The name and sourceURI attributes

Model has a required name attribute of type string. There is no need for id attribute because only one instance of Model is allowed in an SBRML document. The sourceURI attribute is also of type string and gives the origin of the model used in the operation. If the sourceURI attribute is not specified, the actual model representations in SBML format as shown in Figure 4.3 must be carried within the instance of Model.

4.3.2 The sbml association

The sbml association serves as a container element for the SBML model that generates the results encoded in SBRML. As mentioned earlier, this is only required if the sourceURI attribute is not specified.

4.3.3 Example

```

<sbrml>
  .....
  <model name=" Curien2003_MetThr_synthesis" sourceURI="urn:miriam:biomodels.db:BIOMD0000000001" />
  .....
</sbrml>

```

4.4 Operation

The definition of Operation is shown in Figure 4.4. There may be more than one instance of operation in an SBRML document. All the instances of Operation are placed in the operations container element as described in subsection 4.4. Operation is a container for components represented by the classes Method, Software, and Result.

4.4.1 The id and names attributes

The required id and optional name attributes have data types SBRId and string, respectively. The id attribute is used to give the instance of Operation a unique identifier by which other parts of an SBRML model definition can refer to it. The name attribute is intended to be used for giving the instance a human-readable name.

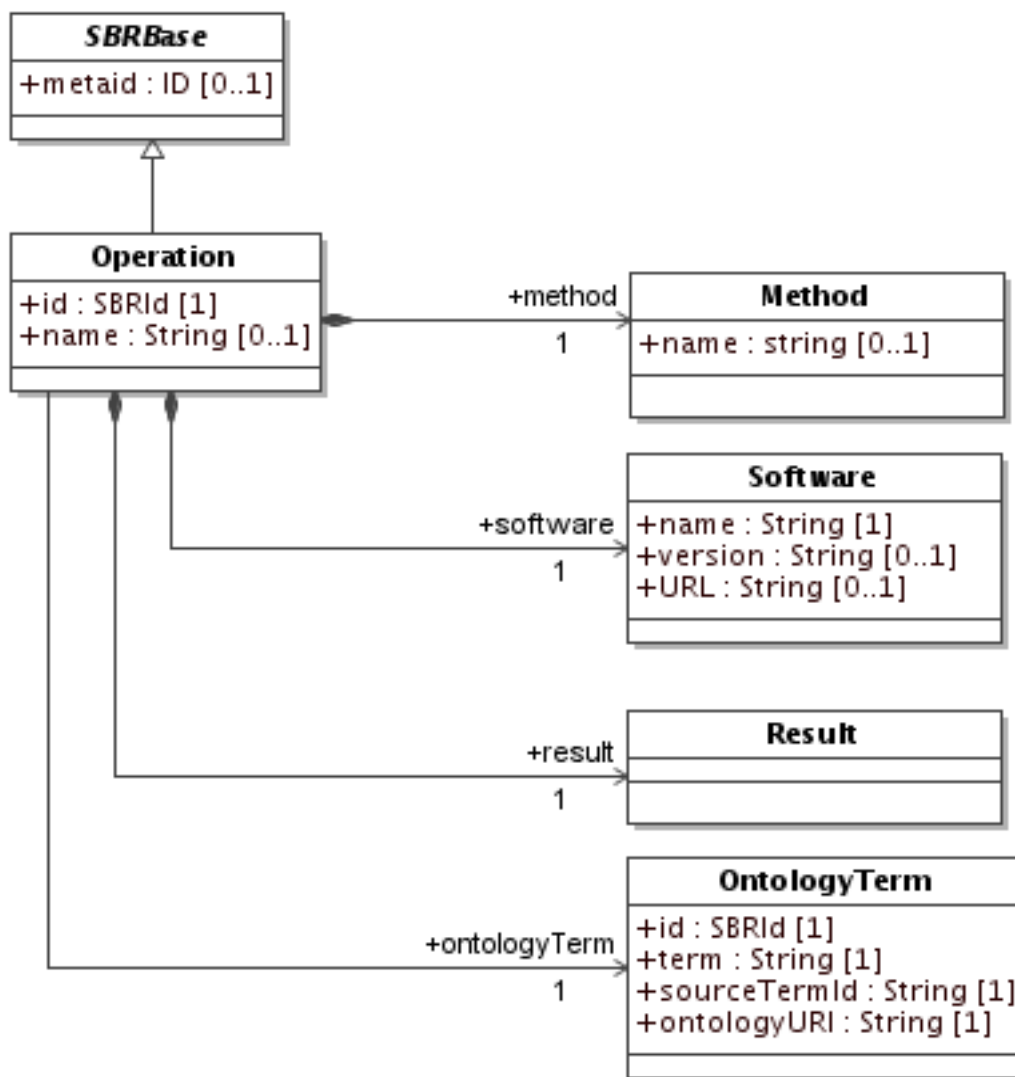

Figure 4.4: The definition of class Operation. A sequence of one or more instances of Operation can be located in a operations container element as described in subsection 4.1.

4.4.2 The ontologyTerm association

The ontologyTerm association is used to reference an external controlled vocabulary/ontology source that defined the name of the instance of Operation class.

4.4.3 Example

```

<sbrml>
  <operations>
    <operation id="op1" name="Steady State" ontologyTerm="term2">
  
```



```

<method name="Newton method" ontologyTerm="term1" />
<software name=" COPASI" version="COPASI 4.4 Build 26" URL="http://www.copasi.org/download" />
<result>.....</result>
</operation>
.....
</operations>
</sbrml>

```

4.5 Method

Method type is used to represent the method used in an operation. The Method type is defined by the Method object class in Figure 4.5

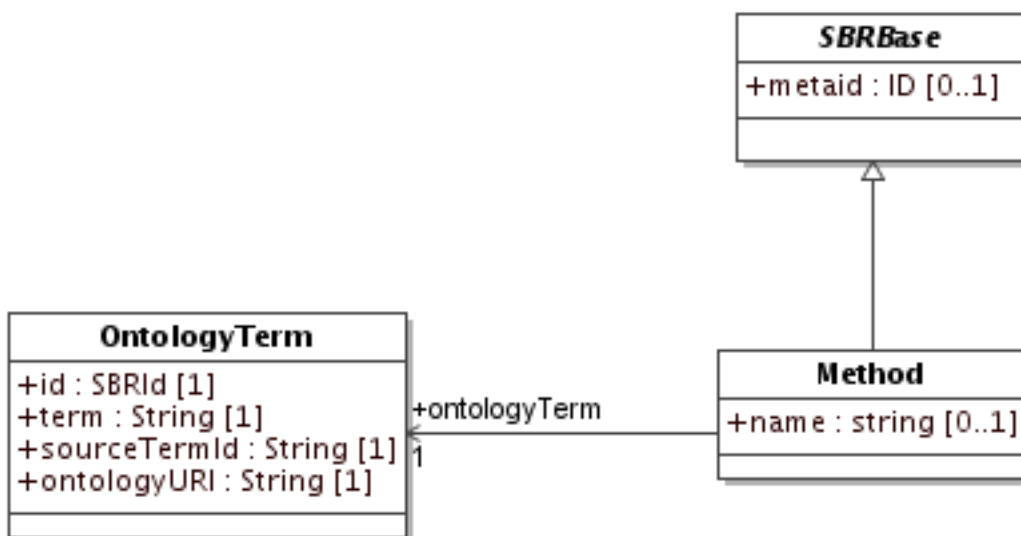

Figure 4.5: The definition of class Method. Only one instance of Method can be located in an instance of Operation

4.5.1 The name attribute

The optional name attributes has data type string. The name attribute is intended to be used for giving the instance a human-readable name. The name of a method used in an operation must be defined in a well known ontology source as indicated by the association to OntologyTerm class.

4.5.2 The ontologyTerm association

The required ontologyTerm association is used to reference an external controlled vocabulary/ontology source that defined name of the instance of Method class.

4.5.3 Example

The following skeleton of method definition illustrates an example use of Method:

```

<sbrml>
.....
  <method name="Newton method" ontologyTerm="term1"/>
.....
</sbrml>

```

4.6 Software

The definition of Software class is shown in Figure 4.6

4.6.1 The name, version, URL attributes

The required name attribute has data type string. There is also an optional version attribute, which can be used to specify the version of the software tool. The optional attribute URL gives the web address of the software.

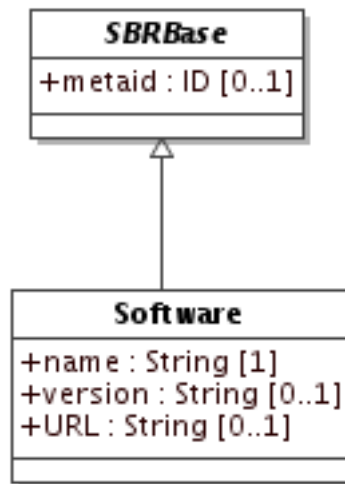

Figure 4.6: The definition of class Software. Only one instance of Software can be located in an instance of Operation.

4.6.2 Example

```
<sbrm>
  .....
  <software name=" COPASI" version="COPASI 4.4 Build 26" URL="http://www.copasi.org/download"/>
  .....
</sbrml>
```

4.7 Result

The definition of the Result class is shown in Figure 4.7. Only one instance of a Result object class is allowed per instance of an Operation, and it must be located inside the <operation> ... </operation> element as described in Section 4.1. Result serves as a container for components of class ResultComponent defined in the next section. Result must contain at least one instance of ResultComponent.

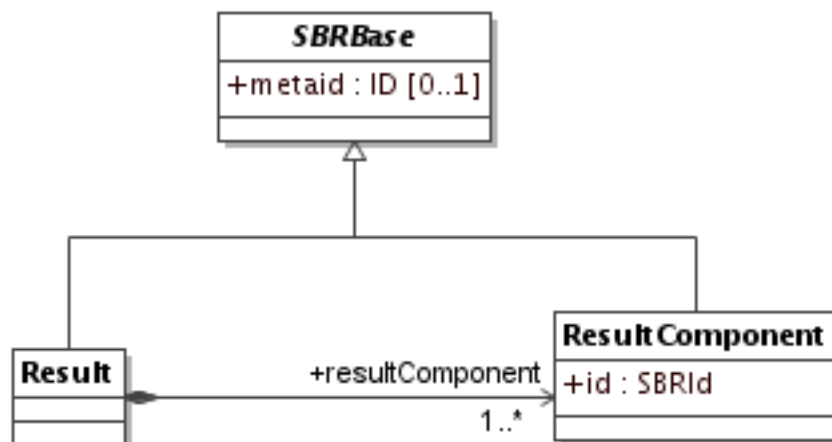

Figure 4.7: The definition of class Result. Only one instance of result is allowed in an instance of Operation. A sequence of one or more instances of ResultComponent can be located in an instance of Result in Sbrml.

4.7.1 Example

```

<sbrml>
.....
<operation>
.....
  <result>
    <resultComponent>.....</resultComponent>
  .....
</result>
</operation>
</sbrml>

```

4.8 Result component

The actual result of the operation performed on an SBML model is defined by the ResultComponent object class. Result in SBRML has two component parts: the description of the result represented by the dimensionDescription association and the result itself represented by the dimension association. This approach provides a flexible structure for representing systems biology results. There must be at least one instance of ResultComponent in result element as mentioned in the above section. The ResultComponent class serves as a container for the instances of components of subclasses of abstract classes DimensionDescription and Dimension. The subclasses allow the ResultComponent to have variable contents. We use a <choice> element to implement the variable content container. This method simply lists within a <choice> element all the elements which can appear in the variable content container, and embed the <choice> element in the container element. Readers should consult the SBRML Schema for implementation details. Figure 4.8 shows the ResultComponent class with all its associated classes.

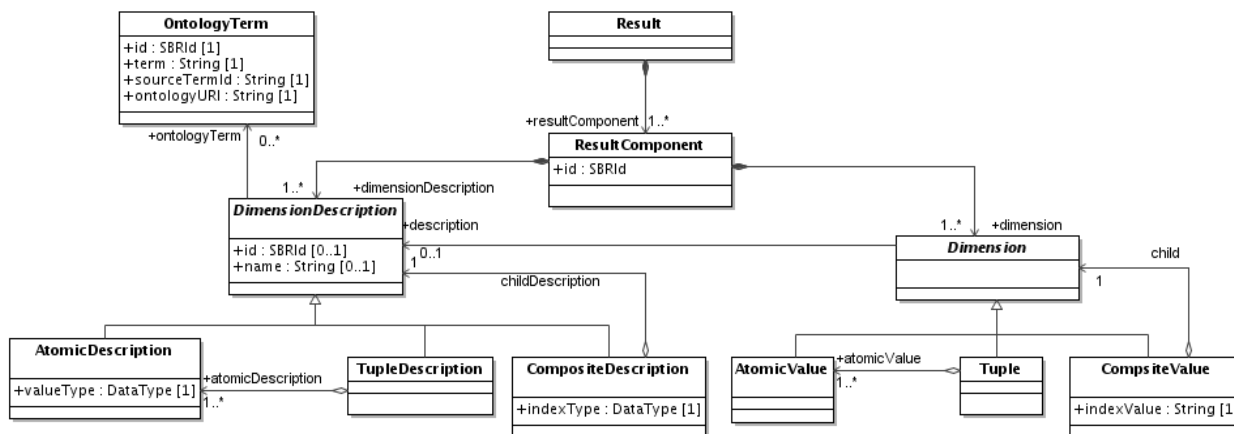

Figure 4.8: The definition of ResultComponent object class with its associated classes. A sequence of one or more instances of ResultComponent can be located in an instance of Result.

4.8.1 The id attribute

The required attribute id has data type SBRIId. The id attribute is used to give the instance of ResultComponent a unique identifier by which other parts of an SBRML model definition can refer to it.

4.9 The dimension description

The structure of ResultComponent is described using the DimensionDescription abstract class (Figure 4.8) with three subclasses: AtomicDescription, TupleDescription and CompositeDescription. It has an optional id attribute of type SBRId and optional name attribute of type string. It also has a relationship to the OntologyTerm object class, which allows the control vocabulary/ontology defined by the external ontology sources for the name attribute to be referenced.

4.10 The composite description

The nesting of dimensions is described using the CompositeDescription class, as defined in Figure 4.8. The CompositeDescription class is a subclass of DimensionDescription object class. It has an implicit relationship to CompositeValue class in that any result described in the CompositeDescription class must be placed in the CompositeValue class. It has a require indexType attribute of type DataType that defines the type of data of the indexValue attribute of CompositeValue class. An instance of CompositeDescription must contain exactly one instance of any of AtomicDescription, TupleDescription or CompositeDescription classes, as indicated by its aggregation relationship to the DimensionDescription.

4.11 The tuple description

Where results contain structured components that are not represented as distinct dimensions, the structure is described using the TupleDescription class, as presented in Figure 4.8. TupleDescription is subclass of DimensionDescription and serves as a container for the instances of AtomicDescription object class. It has an implicit relationship to Tuple class. Any result that is described in the TupleDescription class must be placed in the Tuple class. An instance of TupleDescription class must have at least one instance of AtomicDescription object class, and only one instance of TupleDescription is allowed within the CompositeDescription as described above. The id and name attributes inherited from the super class are optional for this class.

4.12 The atomic description

Where a value in a result can no longer be subdivided, it is described using the AtomicDescription class, as defined in Figure 4.8. The AtomicDescription class is a subclass of DimensionDescription class. It has an implicit relationship to AtomicValue class. Any result that is described in the instance of AtomicDescription class must be placed in the instance of AtomicValue object class. It has a require valueType attribute of type DataType that defines the type of data contained in the instance of AtomicValue class.

4.13 The dimension

A dimension within a result is represented using Dimension abstract class (Figure 4.8) with three subclasses: AtomicValue, Tuple and CompositeValue. The optional *description* relationship to the DimensionDescription object class allows explicit referencing of the instances of subclasses of DimensionDescription object class from the instances of the subclasses of Dimension object class.

4.14 The composite value

A nesting relationship between dimensions is represented using the CompositeValue class, as defined in Figure 4.8. The CompositeValue class is a subclass of Dimension class. It has an implicit relationship to CompositeDescription class. Any result that is described in the CompositeDescription class is placed in the CompositeValue class. It has a require indexValue attribute of type string. The actual data type of indexValue is defined in the indexType attribute of the corresponding CompositeDescription class. An instance of CompositeValue class must contain only one instance of any of AtomicValue, Tuple or CompositeValue, as indicated by its corresponding aggregation relationship to the Dimension.

4.15 The tuple

Structured values that are not described as dimensions are represented by the Tuple class, as presented in Figure 4.8. Tuple is a subclass of Dimension and serves as a container for instances of the AtomicValue class. It has an implicit relationship to TupleDescription. Any result that is described in the TupleDescription class is placed in the Tuple class. An instance of Tuple class must have at least one instance of AtomicValue object class and only one instance of Tuple is allowed within an instance of CompositeValue, as mentioned above.

4.16 The atomic value

Individual results within dimensions or tuples are represented by the AtomicValue class, as defined in Figure 4.8. The AtomicValue class is a subclass of Dimension object class. It has an implicit relationship to AtomicDescription object class. The data that is encoded in the instance of AtomicValue class must be described in the instance of AtomicDescription class.

4.17 Example with tuple and atomic value

```
<sbrml>
.....
<operation id="param_estimate" name="Parameter Estimation" ontologyTerm="term1">
  <result>
    <resultComponent id="main_fitting_result">
      <dimensionDescription>
        <tupleDescription name="Main">
          <atomicDescription name="Objective Value" valueType="float" />
          <atomicDescription name="Root Mean Square" valueType="float" />
          <atomicDescription name="Standard Deviation" valueType="float" />
        </tupleDescription>
      </dimensionDescription>
      <dimension>
        <tuple>
          <atomicValue>12.5015</atomicValue>
          <atomicValue>0.158123</atomicValue>
          <atomicValue>0.159242</atomicValue>
        </tuple>
      </dimension>
    </resultComponent>
    .....
  </result>
</operation>
.....
</sbrml>
```

4.18 Example with composite value(s) and atomic value

```
<sbrml>
.....
<result>
  <resultComponent id="species_conc">
    <dimensionDescription>
      <compositeDescription name="species" indexType="string">
        <atomicDescription name="Concentration" ontologyTerm="term3" valueType="float" />
      </compositeDescription>
    </dimensionDescription>
  </resultComponent>
</result>
.....
</sbrml>
```

```

    </compositeDescription>
  </dimensionDescription>
</dimension>
  <compositeValue indexValue="Phosphohomoserine">
    <atomicValue>141.063</atomicValue>
  </compositeValue>
  <compositeValue indexValue="Inorganic phosphate">
    <atomicValue>10000</atomicValue>
  </compositeValue>
  <compositeValue indexValue="Cysteine">
    <atomicValue>15</atomicValue>
  </compositeValue>
</dimension>
</resultComponent>
.....
</result>
.....
</sbrml>

```

4.19 Example with composite value, tuple and atomic value

```

<sbrml>
.....
<result>
  <resultComponent id="species_con_pnumbers">
    <dimensionDescription>
      <compositeDescription name="species" indexType="string">
        <tupleDescription>
          <atomicDescription name="Concentration" ontologyTerm="term3" valueType="double" />
          <atomicDescription name="Particle Numbers" ontologyTerm="term4" valueType="double" />
        </tupleDescription>
      </compositeDescription>
    </dimensionDescription>
    <dimension>
      <compositeValue indexValue="Phosphohomoserine">
        <tuple>
          <atomicValue>141.063</atomicValue>
          <atomicValue>8.49503e+19</atomicValue>
        </tuple>
      </compositeValue>
      <compositeValue indexValue="Inorganic_phosphate">
        <tuple>
          <atomicValue>10000</atomicValue>
          <atomicValue>6.02214e+21</atomicValue>
        </tuple>
      </compositeValue>
      <compositeValue indexValue="Cysteine">
        <tuple>
          <atomicValue>15</atomicValue>
          <atomicValue>9.03321e+18</atomicValue>
        </tuple>
      </compositeValue>
    </dimension>
  </resultComponent>
.....
</result>
.....
</sbrml>

```

5 Example of simulation results expressed in XML using SBRML

In this section, we present several examples of complete simulation results encoded in XML using SBRML Level 1. We use models from <http://www.ebi.ac.uk/biomodels> for the examples.

5.1 Example of steady state simulation result

```

<?xml version="1.0" encoding="UTF-8"?>
<sbrml xmlns="http://www.sbrml.org/sbrml/level1/version1" version="1.0" level="1.0">
  <ontologyTerms>
    <ontologyTerm id="term1" term="Newton method" sourceTermId="" ontologyURI="TestOntologyURI" />

```

```

<ontologyTerm id="term2" term="Steady State" sourceTermId="" ontologyURI="TestOntologyURI" />
<ontologyTerm id="term3" term="concentration" sourceTermId="SBO:0000196" ontologyURI="http://www.ebi.ac.uk/sbo/" />
<ontologyTerm id="term4" term="particle numbers" sourceTermId="TestId:0000008" ontologyURI="TestOntologyURI" />
<ontologyTerm id="term5" term="flux" sourceTermId="C2348693" ontologyURI="http://www.nlm.nih.gov/research/umls/" />
<ontologyTerm id="term6" term="particle flux" sourceTermId="TestId:00000011" ontologyURI="TestOntologyURI" />
<ontologyTerm id="term7" term="size" sourceTermId="TestId:00000013" ontologyURI="TestOntologyURI" />
</ontologyTerms>
<model name="Curien2003_MetThr_synthesis" sourceURI="urn:miriam:biomodels.db:BIOMD0000000001" />
<operations>
<operation id="op1" ontologyTerm="term2">
<method ontologyTerm="term1" />
<software name=" COPASI" version="COPASI 4.4 Build 26" URL="http://www.copasi.org/download" />
<result>
<resultComponent id="component11">
<dimensionDescription>
<compositeDescription name="species" indexType="string">
<tupleDescription>
<atomicDescription name="Concentration" ontologyTerm="term3" valueType="double" />
<atomicDescription name="Particle Numbers" ontologyTerm="term4" valueType="double" />
</tupleDescription>
</compositeDescription>
</dimensionDescription>
<dimension>
<compositeValue indexValue="Phosphohomoserine">
<tuple>
<atomicValue>141.063</atomicValue>
<atomicValue>8.49503e+19</atomicValue>
</tuple>
</compositeValue>
<compositeValue indexValue="Threonine">
<tuple>
<atomicValue>0</atomicValue>
<atomicValue>0</atomicValue>
</tuple>
</compositeValue>
<compositeValue indexValue="Cystathionine">
<tuple>
<atomicValue>0</atomicValue>
<atomicValue>0</atomicValue>
</tuple>
</compositeValue>
<compositeValue indexValue="Homoserine">
<tuple>
<atomicValue>0</atomicValue>
<atomicValue>0</atomicValue>
</tuple>
</compositeValue>
<compositeValue indexValue="Inorganic_phosphate">
<tuple>
<atomicValue>10000</atomicValue>
<atomicValue>6.02214e+21</atomicValue>
</tuple>
</compositeValue>
<compositeValue indexValue="Cysteine">
<tuple>
<atomicValue>15</atomicValue>
<atomicValue>9.03321e+18</atomicValue>
</tuple>
</compositeValue>
</dimension>
</resultComponent>
<resultComponent id="component2">
<dimensionDescription>
<compositeDescription name="reaction" indexType="string">
<tupleDescription>
<atomicDescription name="Flux" ontologyTerm="term5" valueType="double" />
<atomicDescription name="Particle Flux" ontologyTerm="term6" valueType="double" />
</tupleDescription>
</compositeDescription>
</dimensionDescription>
<dimension>
<compositeValue indexValue="Phosphohomoserine_synthesis">
<tuple>
<atomicValue>1</atomicValue>
<atomicValue>6.02214e+17</atomicValue>
</tuple>

```

```

</compositeValue>
<compositeValue indexValue="Cystathionine_gamma-synthase">
  <tuple>
    <atomicValue>0.152172</atomicValue>
    <atomicValue>9.164e+16</atomicValue>
  </tuple>
</compositeValue>
<compositeValue indexValue="Threonine_Synthase">
  <tuple>
    <atomicValue>0.847828</atomicValue>
    <atomicValue>5.10574e+17</atomicValue>
  </tuple>
</compositeValue>
</dimension>
</resultComponent>
<resultComponent id="componen31">
  <dimensionDescription>
    <compositeDescription name="Compartment" indexType="string">
      <atomicDescription name="Size" ontologyTerm="term7" valueType="double" />
    </compositeDescription>
  </dimensionDescription>
  <dimension>
    <compositeValue indexValue="Cell">
      <atomicValue>1</atomicValue>
    </compositeValue>
  </dimension>
</resultComponent>
</result>
</operation>
</operations>
</sbrml>

```

5.2 Example of time course simulation result

```

<?xml version="1.0" encoding="UTF-8"?>
<sbrml xmlns="http://www.sbrml.org/sbrml/level1/version1" version="1.0" level="1.0">
  <ontologyTerms>
    <ontologyTerm id="term1" term="LSODA" sourceTermId="KISAO:0000094" ontologyURI="http://www.ebi.ac.uk/compneur-srv/kisao/" />
    <ontologyTerm id="term2" term="Time Course" sourceTermId="" ontologyURI="TestOntologyURI" />
    <ontologyTerm id="term3" term="time" sourceTermId="TestId:0000006" ontologyURI="TestOntologyURI" />
    <ontologyTerm id="term4" term="concentration" sourceTermId="SBO:0000196" ontologyURI="http://www.ebi.ac.uk/sbo/" />
    <ontologyTerm id="term5" term="particel numbers" sourceTermId="TestId:0000008" ontologyURI="TestOntologyURI" />
  </ontologyTerms>
  <model name="Curien2003_MetThr_synthesis" sourceURI="urn:miriam:biomodels.db:BIOMD0000000001" />
  <operations>
    <operation id="op1" name="Time Course" ontologyTerm="term2">
      <method name="Deterministic(LSODA)" ontologyTerm="term1" />
      <software name=" COPASI" version="COPASI 4.4 Build 26" URL="http://www.copasi.org" />
    </operation>
  </operations>
  <result>
    <resultComponent id="component1">
      <dimensionDescription>
        <compositeDescription name="Time" ontologyTerm="term3" indexType="double">
          <compositeDescription name="species" indexType="string">
            <tupleDescription>
              <atomicDescription name="Concentration" ontologyTerm="term4" valueType="double" />
              <atomicDescription name="Particle Numbers" ontologyTerm="term5" valueType="integer" />
            </tupleDescription>
          </compositeDescription>
        </compositeDescription>
      </dimensionDescription>
      <dimension>
        <compositeValue indexValue="0">
          <compositeValue indexValue="Phosphohomoserine">
            <tuple>
              <atomicValue>0</atomicValue>
              <atomicValue>0</atomicValue>
            </tuple>
          </compositeValue>
          <compositeValue indexValue="Threonine">
            <tuple>
              <atomicValue>0</atomicValue>
              <atomicValue>0</atomicValue>
            </tuple>
          </compositeValue>
        </dimension>
      </resultComponent>
    </result>
  </operations>
</sbrml>

```



```

<compositeValue indexValue="Cystathionine">
  <tuple>
    <atomicValue>0</atomicValue>
    <atomicValue>0</atomicValue>
  </tuple>
</compositeValue>
<compositeValue indexValue="Homoserine">
  <tuple>
    <atomicValue>0</atomicValue>
    <atomicValue>0</atomicValue>
  </tuple>
</compositeValue>
<compositeValue indexValue="Inorganic phosphate">
  <tuple>
    <atomicValue>10000</atomicValue>
    <atomicValue>6.02214e+21</atomicValue>
  </tuple>
</compositeValue>
<compositeValue indexValue="Cysteine">
  <tuple>
    <atomicValue>15</atomicValue>
    <atomicValue>9.03321e+18</atomicValue>
  </tuple>
</compositeValue>
</compositeValue>
<compositeValue indexValue="1">
<compositeValue indexValue="Phosphohomoserine">
  <tuple>
    <atomicValue>0.996305</atomicValue>
    <atomicValue>5.99989e+17</atomicValue>
  </tuple>
</compositeValue>
<compositeValue indexValue="Threonine">
  <tuple>
    <atomicValue>0</atomicValue>
    <atomicValue>0</atomicValue>
  </tuple>
</compositeValue>
<compositeValue indexValue="Cystathionine">
  <tuple>
    <atomicValue>0</atomicValue>
    <atomicValue>0</atomicValue>
  </tuple>
</compositeValue>
<compositeValue indexValue="Homoserine">
  <tuple>
    <atomicValue>0</atomicValue>
    <atomicValue>0</atomicValue>
  </tuple>
</compositeValue>
<compositeValue indexValue="Inorganic_phosphate">
  <tuple>
    <atomicValue>10000</atomicValue>
    <atomicValue>6.02214e+21</atomicValue>
  </tuple>
</compositeValue>
<compositeValue indexValue="Cysteine">
  <tuple>
    <atomicValue>15</atomicValue>
    <atomicValue>9.03321e+18</atomicValue>
  </tuple>
</compositeValue>
</compositeValue>
<compositeValue indexValue="2">
<compositeValue indexValue="Phosphohomoserine">
  <tuple>
    <atomicValue>1.98526</atomicValue>
    <atomicValue>1.19555e+18</atomicValue>
  </tuple>
</compositeValue>
<compositeValue indexValue="Threonine">
  <tuple>
    <atomicValue>0</atomicValue>
    <atomicValue>0</atomicValue>
  </tuple>
</compositeValue>

```

```

<compositeValue indexValue="Cystathionine">
  <tuple>
    <atomicValue>0</atomicValue>
    <atomicValue>0</atomicValue>
  </tuple>
</compositeValue>
<compositeValue indexValue="Homoserine">
  <tuple>
    <atomicValue>0</atomicValue>
    <atomicValue>0</atomicValue>
  </tuple>
</compositeValue>
<compositeValue indexValue="Inorganic_phosphate">
  <tuple>
    <atomicValue>10000</atomicValue>
    <atomicValue>6.02214e+21</atomicValue>
  </tuple>
</compositeValue>
<compositeValue indexValue="Cysteine">
  <tuple>
    <atomicValue>15</atomicValue>
    <atomicValue>9.03321e+18</atomicValue>
  </tuple>
</compositeValue>
</compositeValue>
<compositeValue indexValue="3">
<compositeValue indexValue="Phosphohomoserine">
  <tuple>
    <atomicValue>2.96693</atomicValue>
    <atomicValue>1.78672e+18</atomicValue>
  </tuple>
</compositeValue>
<compositeValue indexValue="Threonine">
  <tuple>
    <atomicValue>0</atomicValue>
    <atomicValue>0</atomicValue>
  </tuple>
</compositeValue>
<compositeValue indexValue="Cystathionine">
  <tuple>
    <atomicValue>0</atomicValue>
    <atomicValue>0</atomicValue>
  </tuple>
</compositeValue>
<compositeValue indexValue="Homoserine">
  <tuple>
    <atomicValue>0</atomicValue>
    <atomicValue>0</atomicValue>
  </tuple>
</compositeValue>
<compositeValue indexValue="Inorganic_phosphate">
  <tuple>
    <atomicValue>10000</atomicValue>
    <atomicValue>6.02214e+21</atomicValue>
  </tuple>
</compositeValue>
<compositeValue indexValue="Cysteine">
  <tuple>
    <atomicValue>15</atomicValue>
    <atomicValue>9.03321e+18</atomicValue>
  </tuple>
</compositeValue>
</compositeValue>
<compositeValue indexValue="4">
<compositeValue indexValue="Phosphohomoserine">
  <tuple>
    <atomicValue>3.94136</atomicValue>
    <atomicValue>2.37354e+18</atomicValue>
  </tuple>
</compositeValue>
<compositeValue indexValue="Threonine">
  <tuple>
    <atomicValue>0</atomicValue>
    <atomicValue>0</atomicValue>
  </tuple>
</compositeValue>

```

```

<compositeValue indexValue="Cystathionine">
  <tuple>
    <atomicValue>0</atomicValue>
    <atomicValue>0</atomicValue>
  </tuple>
</compositeValue>
<compositeValue indexValue="Homoserine">
  <tuple>
    <atomicValue>0</atomicValue>
    <atomicValue>0</atomicValue>
  </tuple>
</compositeValue>
<compositeValue indexValue="Inorganic_phosphate">
  <tuple>
    <atomicValue>10000</atomicValue>
    <atomicValue>6.02214e+21</atomicValue>
  </tuple>
</compositeValue>
<compositeValue indexValue="Cysteine">
  <tuple>
    <atomicValue>15</atomicValue>
    <atomicValue>9.03321e+18</atomicValue>
  </tuple>
</compositeValue>
</compositeValue>
<compositeValue indexValue="5">
<compositeValue indexValue="Phosphohomoserine">
  <tuple>
    <atomicValue>4.90862</atomicValue>
    <atomicValue>2.95604e+18</atomicValue>
  </tuple>
</compositeValue>
<compositeValue indexValue="Threonine">
  <tuple>
    <atomicValue>0</atomicValue>
    <atomicValue>0</atomicValue>
  </tuple>
</compositeValue>
<compositeValue indexValue="Cystathionine">
  <tuple>
    <atomicValue>0</atomicValue>
    <atomicValue>0</atomicValue>
  </tuple>
</compositeValue>
<compositeValue indexValue="Homoserine">
  <tuple>
    <atomicValue>0</atomicValue>
    <atomicValue>0</atomicValue>
  </tuple>
</compositeValue>
<compositeValue indexValue="Inorganic_phosphate">
  <tuple>
    <atomicValue>10000</atomicValue>
    <atomicValue>6.02214e+21</atomicValue>
  </tuple>
</compositeValue>
<compositeValue indexValue="Cysteine">
  <tuple>
    <atomicValue>15</atomicValue>
    <atomicValue>9.03321e+18</atomicValue>
  </tuple>
</compositeValue>
</compositeValue>
</dimension>
</resultComponent>
</result>
</operation>
</operations>
</sbrml>

```

5.3 Example of parameter scan result

```
<?xml version="1.0" encoding="UTF-8"?>
```

```

<sbrml xmlns="http://www.sbrml.org/sbrml/level1" version="1.0" level="1.0">
  <ontologyTerms>
    <ontologyTerm id="term1" term="Parameter Scan" sourceTermId="Test:00001" ontologyURI="TestOntologyURI" />
    <ontologyTerm id="term2" term="Newton method" sourceTermId="Test:00002" ontologyURI="TestOntologyURI" />
    <ontologyTerm id="term3" term="concentration" sourceTermId="SBO:0000196" ontologyURI="http://www.ebi.ac.uk/sbo/" />
  </ontologyTerms>
  <model name="Curien2003_MetThr_synthesis" sourceURI="urn:miriam.biomodels.db:BIOMD00000000068" />
  <operations>
    <operation id="op1" name="Parameter Scan" ontologyTerm="term1">
      <method ontologyTerm="term2" />
      <software name=" COPASI" version="COPASI 4.4 Build 26" URL="http://www.copasi.org/download" />
    </operation>
    <result>
      <resultComponent id="component1">
        <dimensionDescription>
          <compositeDescription name="parameter" indexValue="string">
            <compositeDescription name="value" indexType="double">
              <compositeDescription name="species" indexType="string">
                <atomicDescription name="Concentration" ontologyTerm="term3" type="double" />
              </compositeDescription>
            </compositeDescription>
          </compositeDescription>
        </dimensionDescription>
        <dimension>
          <compositeValue indexValue="AdoMet">
            <compositeValue indexValue="0">
              <compositeValue indexValue="Phosphohomoserine">
                <atomicValue>1777</atomicValue>
              </compositeValue>
            </compositeValue>
          </compositeValue>
          <compositeValue indexValue="25">
            <compositeValue indexValue="Phosphohomoserine">
              <atomicValue>93.55</atomicValue>
            </compositeValue>
          </compositeValue>
          <compositeValue indexValue="50">
            <compositeValue indexValue="Phosphohomoserine">
              <atomicValue>42.24</atomicValue>
            </compositeValue>
          </compositeValue>
          <compositeValue indexValue="75">
            <compositeValue indexValue="Phosphohomoserine">
              <atomicValue>36.29</atomicValue>
            </compositeValue>
          </compositeValue>
          <compositeValue indexValue="100">
            <compositeValue indexValue="Phosphohomoserine">
              <atomicValue>34.78</atomicValue>
            </compositeValue>
          </compositeValue>
        </dimension>
      </resultComponent>
    </result>
  </operation>
</operations>
</sbrml>

```

5.4 Online example of simulation results

Please visit <http://turing.mib.man.ac.uk:8080/CopasiWeb/CopasiWebUI/> for more examples of simulation results encoded in SBRML.

Acknowledgements

The authors are grateful to the BBSRC and EPSRC for funding of this work through the Manchester Centre for Integrative Systems Biology.

Appendix A: Complete SBRML object model

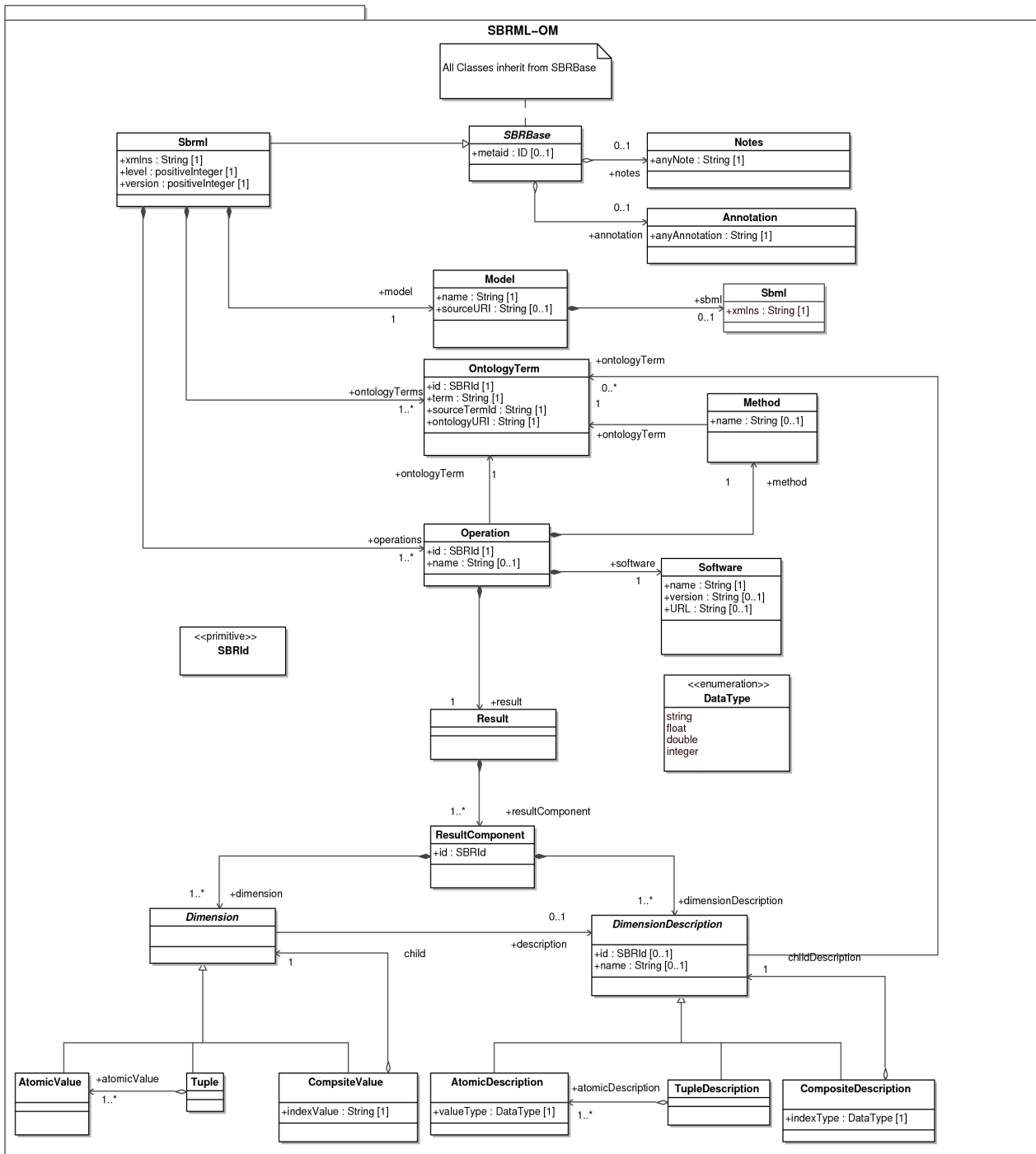

Appendix B: XML Schema for SBRML

```
<?xml version="1.0" encoding="UTF-8"?>
<xsd:schema targetNamespace="http://www.sbrml.org/sbrml/level1/version1" xmlns="http://www.sbrml.org/sbrml/level1/version1"
xmlns:sbml="http://www.sbml.org/sbml/level2/version3" xmlns:xsi="http://www.w3.org/2001/XMLSchema-instance"
xmlns:xsd="http://www.w3.org/2001/XMLSchema" elementFormDefault="qualified" attributeFormDefault="unqualified">
<xsd:annotation>
  <xsd:documentation>
    * Filename : sbrml.xsd * Description: XML Schema for SBRML Level 1 Version 1 * Author(s) : Joseph O. Dada, Norman W.Paton,
    and Pedro Mendes
  </xsd:documentation>
</xsd:annotation>
<!--The definition of new primitive types follows.-->
<xsd:simpleType name="SBRId">
  <xsd:annotation>
    <xsd:documentation>
      The type SBRId is used throughout SBRML as the type of the 'id' attributes on model elements.
    </xsd:documentation>
  </xsd:annotation>
  <xsd:restriction base="xsd:string">
    <xsd:pattern value="(\\[[a-z][A-Z][\\[[a-z][A-Z][0-9]]*)" />
  </xsd:restriction>
</xsd:simpleType>
<xsd:simpleType name="DataType">
  <xsd:annotation>
    <xsd:documentation>
      The enumeration type "DataType" is used to specify the type of "valueType" attribute of atomicDescription and "indexType"
      attribute of the compositeDescription elements.
    </xsd:documentation>
  </xsd:annotation>
  <xsd:restriction base="xsd:string">
    <xsd:enumeration value="string" />
    <xsd:enumeration value="float" />
    <xsd:enumeration value="double" />
    <xsd:enumeration value="integer" />
  </xsd:restriction>
</xsd:simpleType>
<!--Definition of SBRBase-->
<xsd:complexType name="SBRBase" abstract="true">
  <xsd:annotation>
    <xsd:documentation>
      The SBRBase type is the base type of all main components in SBRML. It supports attaching metadata, notes and annotations
      to components.
    </xsd:documentation>
  </xsd:annotation>
  <xsd:sequence>
    <xsd:element name="notes" minOccurs="0">
      <xsd:complexType>
        <xsd:sequence>
          <xsd:any namespace="http://www.w3.org/1999/xhtml" processContents="skip" minOccurs="0" maxOccurs="unbounded" />
        </xsd:sequence>
      </xsd:complexType>
    </xsd:element>
    <xsd:element name="annotation" minOccurs="0">
      <xsd:complexType>
        <xsd:sequence>
          <xsd:any processContents="skip" minOccurs="0" maxOccurs="unbounded" />
        </xsd:sequence>
      </xsd:complexType>
    </xsd:element>
  </xsd:sequence>
  <xsd:attribute name="metaid" type="xsd:ID" use="optional" />
</xsd:complexType>
<!--Definition of main SBRML classes -->
<xsd:complexType name="OntologyTerm">
  <xsd:complexContent>
    <xsd:extension base="SBRBase">
      <xsd:attribute name="id" use="required" type="SBRId" />
      <xsd:attribute name="term" use="required" type="xsd:string" />
      <xsd:attribute name="sourceTermId" use="required" type="xsd:string" />
      <xsd:attribute name="ontologyURI" use="required" type="xsd:anyURI" />
    </xsd:extension>
  </xsd:complexContent>
</xsd:complexType>
```

```

<xsd:complexType name="Model">
  <xsd:complexContent>
    <xsd:extension base="SBRBase">
      <xsd:attribute name="name" use="required" type="xsd:string" />
      <xsd:attribute name="sourceURI" use="optional" type="xsd:anyURI" />
    </xsd:extension>
  </xsd:complexContent>
</xsd:complexType>
<xsd:complexType name="Operation">
  <xsd:complexContent>
    <xsd:extension base="SBRBase">
      <xsd:sequence>
        <xsd:element name="method" type="Method" />
        <xsd:element name="software" type="Software" minOccurs="0" />
        <xsd:element name="result" type="Result" />
      </xsd:sequence>
      <xsd:attribute name="id" use="required" type="SBRId" />
      <xsd:attribute name="name" use="required" type="xsd:string" />
      <xsd:attribute name="ontologyTerm" use="required" type="xsd:string" />
    </xsd:extension>
  </xsd:complexContent>
</xsd:complexType>
<xsd:complexType name="Method">
  <xsd:complexContent>
    <xsd:extension base="SBRBase">
      <xsd:attribute name="name" use="required" type="xsd:string" />
      <xsd:attribute name="ontologyTerm" use="required" type="xsd:string" />
    </xsd:extension>
  </xsd:complexContent>
</xsd:complexType>
<xsd:complexType name="Software">
  <xsd:complexContent>
    <xsd:extension base="SBRBase">
      <xsd:attribute name="name" use="required" type="xsd:string" />
      <xsd:attribute name="URL" use="optional" type="xsd:string" />
      <xsd:attribute name="version" use="optional" type="xsd:string" />
    </xsd:extension>
  </xsd:complexContent>
</xsd:complexType>
<xsd:complexType name="Result">
  <xsd:complexContent>
    <xsd:extension base="SBRBase">
      <xsd:sequence>
        <xsd:element name="resultComponent" type="ResultComponent" maxOccurs="unbounded" />
      </xsd:sequence>
    </xsd:extension>
  </xsd:complexContent>
</xsd:complexType>
<xsd:complexType name="ResultComponent">
  <xsd:complexContent>
    <xsd:extension base="SBRBase">
      <xsd:sequence>
        <xsd:element name="dimensionDescription">
          <xsd:complexType>
            <xsd:choice>
              <xsd:element name="compositeDescription" type="CompositeDescription" maxOccurs="unbounded" />
              <xsd:element name="tupleDescription" type="TupleDescription" maxOccurs="unbounded" />
              <xsd:element name="atomicDescription" type="AtomicDescription" maxOccurs="unbounded" />
            </xsd:choice>
          </xsd:complexType>
        </xsd:element>
        <xsd:element name="dimension">
          <xsd:complexType>
            <xsd:choice>
              <xsd:element name="compositeValue" type="CompositeValue" maxOccurs="unbounded" />
              <xsd:element name="tuple" type="Tuple" maxOccurs="unbounded" />
              <xsd:element name="atomicValue" type="xsd:string" maxOccurs="unbounded" />
            </xsd:choice>
          </xsd:complexType>
        </xsd:element>
      </xsd:sequence>
      <xsd:attribute name="id" use="required" type="SBRId" />
      <xsd:attribute name="name" use="optional" type="xsd:string" />
    </xsd:extension>
  </xsd:complexContent>
</xsd:complexType>

```

```

<xsd:complexType name="CompositeDescription">
  <xsd:complexContent>
    <xsd:extension base="SBRBase">
      <xsd:choice>
        <xsd:element name="compositeDescription" type="CompositeDescription" />
        <xsd:element name="tupleDescription" type="TupleDescription" />
        <xsd:element name="atomicDescription" type="AtomicDescription" />
      </xsd:choice>
      <xsd:attribute name="id" use="optional" type="SBRId" />
      <xsd:attribute name="name" use="required" type="xsd:string" />
      <xsd:attribute name="ontologyTerm" use="optional" type="SBRId" />
      <xsd:attribute name="indexType" use="required" type="DataType" />
    </xsd:extension>
  </xsd:complexContent>
</xsd:complexType>
<xsd:complexType name="TupleDescription">
  <xsd:complexContent>
    <xsd:extension base="SBRBase">
      <xsd:sequence>
        <xsd:element name="atomicDescription" type="AtomicDescription" maxOccurs="unbounded" />
      </xsd:sequence>
      <xsd:attribute name="id" use="optional" type="SBRId" />
      <xsd:attribute name="name" use="optional" />
      <xsd:attribute name="ontologyTerm" use="optional" type="SBRId" />
    </xsd:extension>
  </xsd:complexContent>
</xsd:complexType>
<xsd:complexType name="AtomicDescription">
  <xsd:complexContent>
    <xsd:extension base="SBRBase">
      <xsd:attribute name="id" use="optional" type="SBRId" />
      <xsd:attribute name="name" use="required" type="xsd:string" />
      <xsd:attribute name="ontologyTerm" use="optional" type="SBRId" />
      <xsd:attribute name="valueType" use="required" type="DataType" />
    </xsd:extension>
  </xsd:complexContent>
</xsd:complexType>
<xsd:complexType name="CompositeValue">
  <xsd:complexContent>
    <xsd:extension base="SBRBase">
      <xsd:choice>
        <xsd:element name="compositeValue" type="CompositeValue" maxOccurs="unbounded" />
        <xsd:element name="tuple" type="Tuple" />
        <xsd:element name="atomicValue" type="xsd:string" />
      </xsd:choice>
      <xsd:attribute name="description" use="optional" type="SBRId" />
      <xsd:attribute name="indexValue" use="required" type="xsd:string" />
    </xsd:extension>
  </xsd:complexContent>
</xsd:complexType>
<xsd:complexType name="Tuple">
  <xsd:complexContent>
    <xsd:extension base="SBRBase">
      <xsd:sequence>
        <xsd:element name="atomicValue" type="xsd:string" maxOccurs="unbounded" />
      </xsd:sequence>
    </xsd:extension>
  </xsd:complexContent>
</xsd:complexType>
<xsd:complexType name="Sbrml">
  <xsd:complexContent>
    <xsd:extension base="SBRBase">
      <xsd:sequence>
        <xsd:element name="ontologyTerms">
          <xsd:complexType>
            <xsd:sequence>
              <xsd:element name="ontologyTerm" type="OntologyTerm" maxOccurs="unbounded" />
            </xsd:sequence>
          </xsd:complexType>
        </xsd:element>
        <xsd:element name="model" type="Model" />
        <xsd:element name="operations">
          <xsd:complexType>
            <xsd:sequence>
              <xsd:element name="operation" type="Operation" maxOccurs="unbounded" />
            </xsd:sequence>
          </xsd:complexType>
        </xsd:element>
      </xsd:sequence>
    </xsd:extension>
  </xsd:complexContent>
</xsd:complexType>

```



```

    </xsd:complexType>
  </xsd:element>
</xsd:sequence>
<xsd:attribute name="level" type="xsd:positiveInteger" use="required" fixed="1" />
<xsd:attribute name="version" type="xsd:positiveInteger" use="required" fixed="1" />
</xsd:extension>
</xsd:complexContent>
</xsd:complexType>
<!--The (only) top-level element allowed in an SBRML document.-->
<xsd:element name="sbrml" type="Sbrml" />
</xsd:schema>

```

References

- Biron, P. V. and Malhotra, A. (2000). XML Schema part 2: Datatypes (W3C candidate recommendation 24 October 2000). Available via the World Wide Web at <http://www.w3.org/TR/xmlschema-2/>.
- Bosak, J. and Bray, T. (1999). XML and the second-generation Web. *Scientific American*, 280(5):89-93.
- Bray, T., D. Hollander, D., and Layman, A. (1999). Namespaces in XML. World Wide Web Consortium 14-January-1999. Available via the World Wide Web at <http://www.w3.org/TR/1999/REC-xml-names-19990114/>.
- Bray, T., Paoli, J., Sperberg-McQueen, C. M., and Maler, E. (2000). Extensible markup language (XML) 1.0 (second edition), W3C recommendation 6-October-2000. Available via the World Wide Web at <http://www.w3.org/TR/1998/REC-xml-19980210>.
- Bray, T., Paoli, J., Sperberg-McQueen, C. M., Maler, E., and Yergeau, F. (2004). Extensible markup language (XML) 1.0 (third edition), W3C recommendation 4-February-2004. Available via the World Wide Web at <http://www.w3.org/TR/2004/REC-xml-20040204>.
- Hucka, M., Finney, A., Hoops, S., Keating, M., and Le Nov`re, N. (2007). Systems Biology Markup Language (SBML) Level 2: Structures and facilities for basic model definitions. Available via the World Wide Web at <http://www.sbml.org>.
- Thompson, H. S., Beech, D., Maloney, M., and Mendelsohn, N. (2000). XML Schema part 1: Structures (W3C candidate recommendation 24 October 2000). Available via the World Wide Web at <http://www.w3.org/TR/xmlschema-1/>.